



Planning Act 2008
Infrastructure Planning
(Applications Prescribed
Forms and Procedure)
Regulations 2009

North Lincolnshire Green Energy Park

APFP Regulation 5(2)(o)

Volume 4

4.10 Indicative Landscape and
Biodiversity Plans

PINS reference: EN010116

December 2022

Revision number: 1



The North Lincolnshire Green Energy Park Development Consent Order

4.10 Indicative Landscape and Biodiversity Plans

Date: December 2022

PINS reference: EN010116

Application Document Reference: 4.10

Author: LDA Design

CONTENTS

CONTENTS.....	1
1. INTRODUCTION	2
1.1 General	2
2. SCHEDULE OF PLANS INCLUDED IN THIS APPLICATION DOCUMENT	3

1. INTRODUCTION

1.1 General

1.1.1 The following Plans have been prepared to accompany the application for a Development Consent Order (DCO), made by the Applicant to the Secretary of State (SoS) via the Planning Inspectorate (the Inspectorate).

1.1.2 A detailed description of the Project can be found in Chapter 3 of the ES (**Document Reference 6.2.3**).

1.1.3 These Plans comprise part of the suite of Application documentation and are included in the Application in compliance with Regulation 5(2)(o) of the Infrastructure Planning (Applications: Prescribed Forms and Procedure) Regulations 2009 (the 2009 Regulations), which requires:

(o) any other plans, drawings and sections necessary to describe the proposals for which development consent is sought, showing details of design, external appearance, and the preferred layout of buildings or structures, drainage, surface water management, means of vehicular and pedestrian access, any car parking to be provided, and means of landscaping

1.1.4 These Plans are also being submitted under Regulation 5(4) of the 2009 Regulations which states:



"Where a plan comprises three or more separate sheets a key plan must be provided showing the relationship between the different sheets."

1.1.5 To assist the interpretation of these Plans, a key plan shows ten separate sheets which cover the Order Limits. Where there are no works shown on a separate sheet, "Sheet X Not Used" is shown on the key plan. Only the sheets showing relevant information are provided.

1.1.6 These Plans are part of the Application documentation and should be read alongside and are informed by the other Application documents.

2. SCHEDULE OF PLANS INCLUDED IN THIS APPLICATION DOCUMENT

Drawing Number	Drawing Title	Revision
NLGEP-LDA-XX-XX-DR-L-0100	Indicative Landscape and Biodiversity Plan Sheet Plan	P0
NLGEP-LDA-XX-XX-DR-L-0104	Indicative Landscape and Biodiversity Plan Sheet 4	P1
NLGEP-LDA-XX-XX-DR-L-0105	Indicative Landscape and Biodiversity Plan Sheet 5	P1
NLGEP-LDA-XX-XX-DR-L-0106	Indicative Landscape and Biodiversity Plan Sheet 6	P1
NLGEP-LDA-XX-XX-DR-L-0107	Indicative Landscape and Biodiversity Plan Sheet 7	P0
NLGEP-LDA-XX-XX-DR-L-0108	Indicative Landscape and Biodiversity Plan Sheet 8	P0
NLGEP-LDA-XX-XX-DR-L-0109	Indicative Landscape and Biodiversity Plan Sheet 9	P0

	DCO Limits
	Land excluded from DCO Limits
Sheet 1	not used
Sheet 2	not used
Sheet 3	not used
Sheet 4	NLGEPLDA-XX-XX-DR-L-0104
Sheet 5	NLGEPLDA-XX-XX-DR-L-0105
Sheet 6	NLGEPLDA-XX-XX-DR-L-0106
Sheet 7	NLGEPLDA-XX-XX-DR-L-0107
Sheet 8	NLGEPLDA-XX-XX-DR-L-0108
Sheet 9	NLGEPLDA-XX-XX-DR-L-0109
Sheet 10	not used

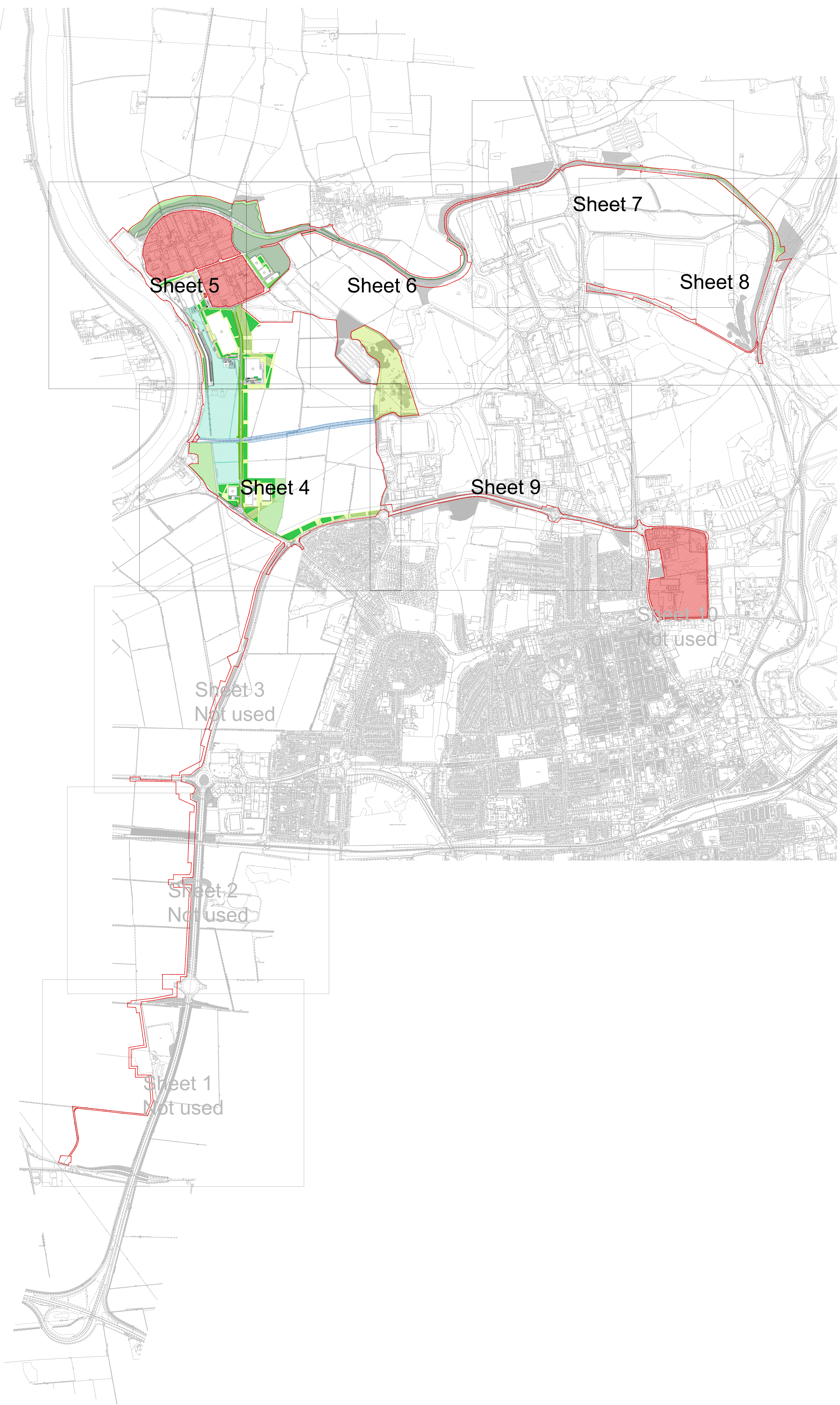

PO	Issued For DCO Submission	25/02/22	TE	ER	RP
Rev	Description	Date	Issd	Rev'd	App'd

DCO SUBMISSION

Project Stage

INFORMATION

Status of Drawing

Client



Client: NORTH LINCOLNSHIRE GREEN ENERGY PARK LTD
 Consultant: LDA Design Consulting Ltd
 Project: NORTH LINCOLNSHIRE GREEN ENERGY PARK
 Title: Indicative Landscape and Biodiversity Plans Sheet Plan

Planning Inspectorate No:	Scale: 1:10,000
EN010116	
Drawn By: EB	Checked By: RP
Approved By: RP	
Drawing No: NLGEPLDA-XX-XX-DR-L-0100	Revision: PO

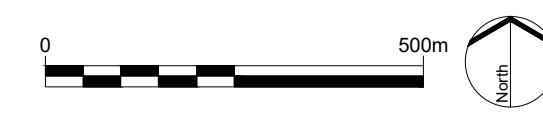

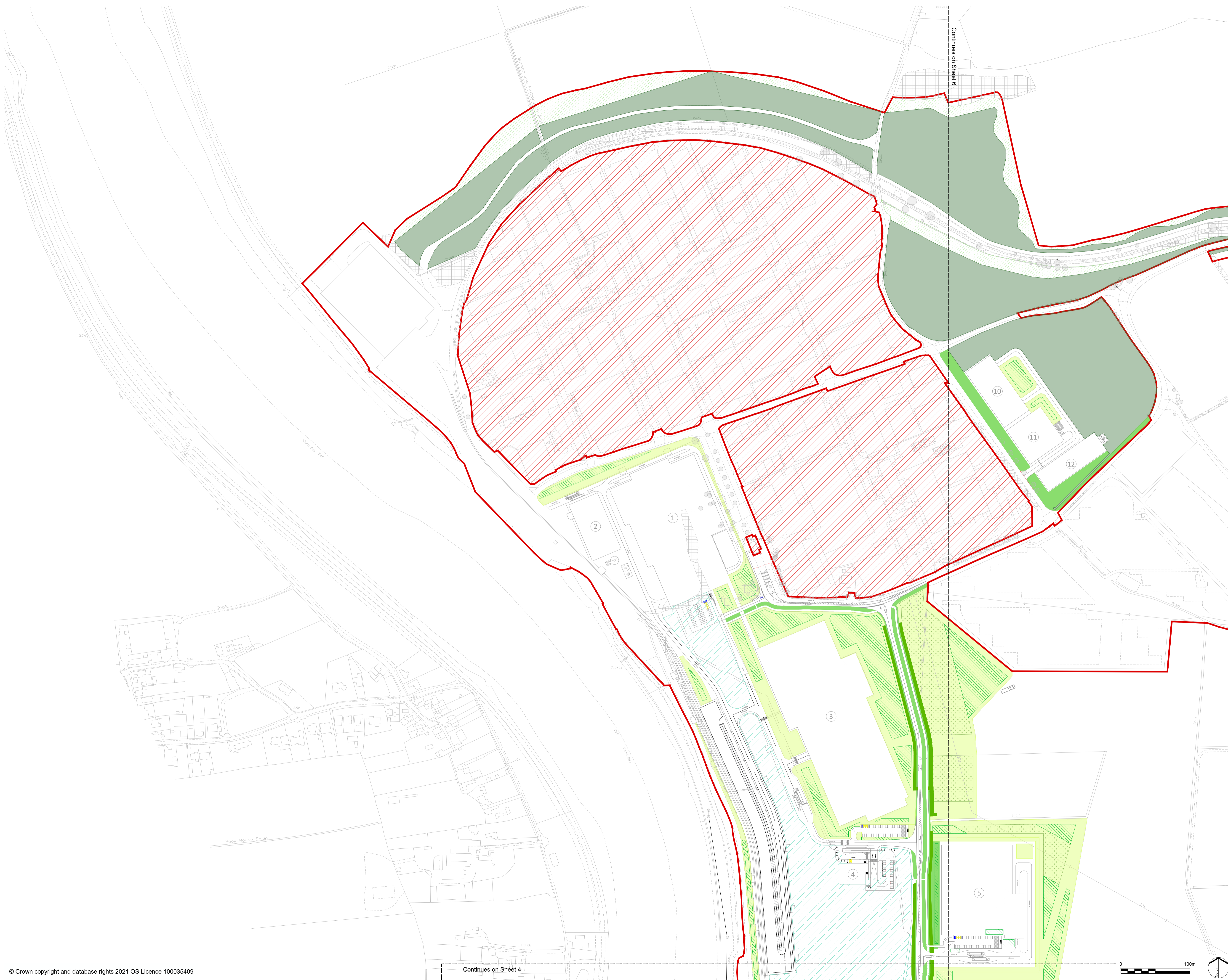

- DCO Limits
- Land excluded from DCO Limits
- Understorey/Ground Cover**
 - Grassland
 - Grassland/Wildflower
 - Wildflower & Wildflower Underplanting
 - Wetland Habitat (including wet woodland trees)
- Tree Planting**
 - Native Woodland/Hedgerow
 - Formal Tree Planting
 - Low Scrub Planting Under Pylons
- SuDS Features**
 - Road Swales/Drains
- Existing Landscape Enhancements**
 - Common land (identified for biodiversity enhancement)
 - Ditch Enhancement
- Existing Landscape**
 - Existing Trees and Hedgerows

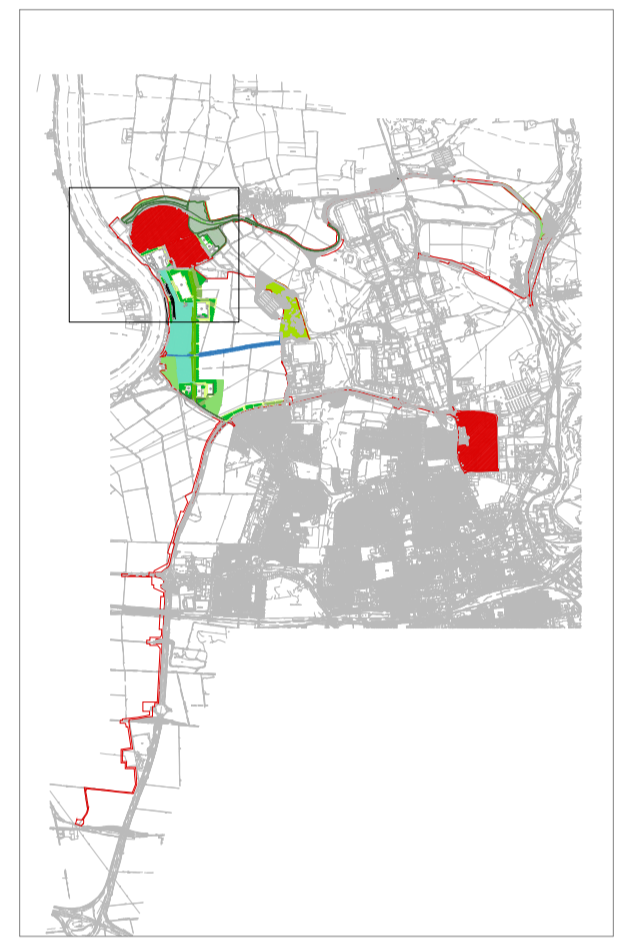

P1	Update to legend	06/12/22	EB	EB	EB
PO	Issued For DCO Submission	25/02/22	TE	EB	RP
Rev	Description	Date	Iss'd	Rev'd	App'd

DCO SUBMISSION

Project Stage

INFORMATION

Status of Drawing

Client

Level 33, Euston Tower, 296 Euston Road, London, NW1 3DF

Client: NORTH LINCOLNSHIRE GREEN ENERGY PARK LTD
 Consultant: LDA Design Consulting Ltd
 Project: NORTH LINCOLNSHIRE GREEN ENERGY PARK
 Dwg Title: Indicative Landscape and Biodiversity Plan Sheet 5

Planning Inspectorate No. EN010116	Scale/A1 1:2,500	
Drawn/Designed By: EB	Checked By: RP	Approved By: RP
Drawing No. NLGEP-LDA-XX-XX-DR-L-0105	Revision P1	

Continues on Sheet 4

Continues on Sheet 6



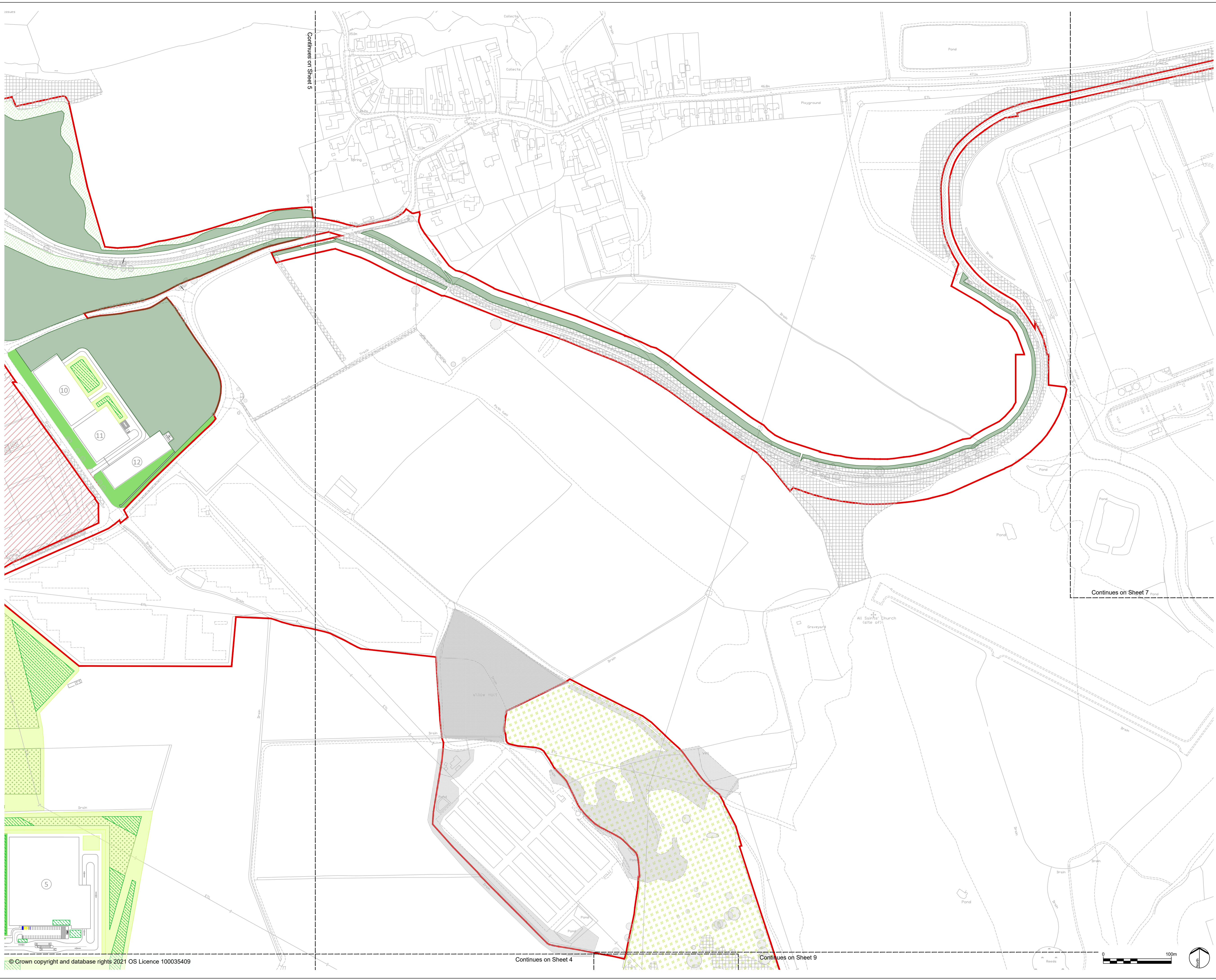

- DCO Limits
- Land excluded from DCO Limits
- Understorey/Ground Cover**
 - Grassland
 - Wildflower & Wildflower Underplanting
 - Grassland/Wildflower
 - Wetland Habitat (including wet woodland trees)
- Tree Planting**
 - Native Woodland/Hedgerow
 - Formal Tree Planting
 - Low Scrub Planting Under Pylons
- SuDS Features**
 - Road Swales/Drains
- Existing Landscape Enhancements**
 - Common land (identified for biodiversity enhancement)
- Existing Landscape**
 - Existing Trees and Hedgerows

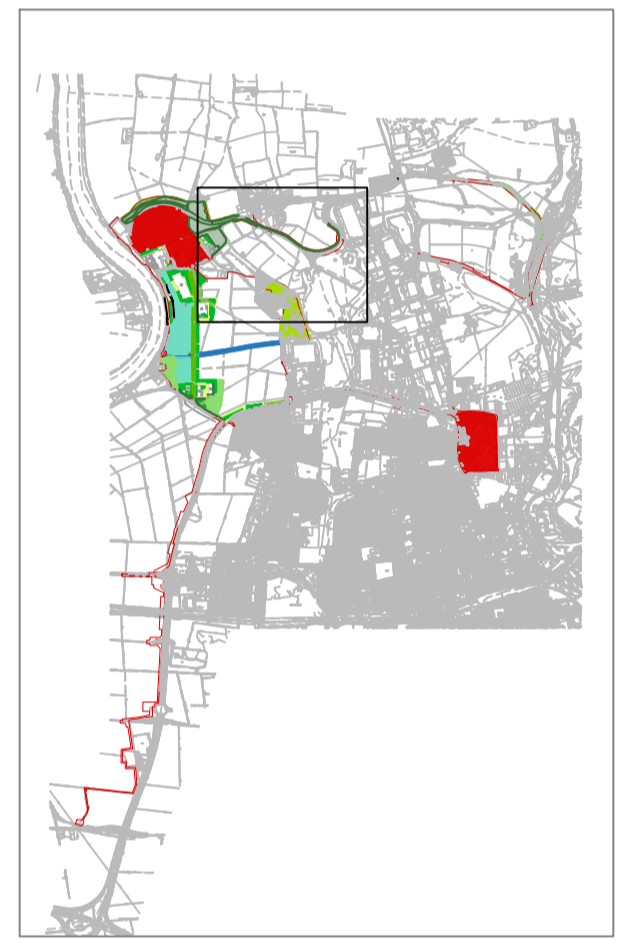

P1	Update to legend	06/12/22	EB	EB	RP
PO	Issued For DCO Submission	25/02/22	TE	EB	RP
Rev	Description	Date	Iss'd	Rev'd	App'd

DCO SUBMISSION

Project Stage

INFORMATION

Status of Drawing

Client



Level 33, Euston Tower, 286 Euston Road,
London, NW1 3DF

Client: NORTH LINCOLNSHIRE GREEN ENERGY PARK LTD
 Consultant: LDA Design Consulting Ltd
 Project: NORTH LINCOLNSHIRE GREEN ENERGY PARK
 Dwg Title: Indicative Landscape and Biodiversity Plan
 Sheet 6

Planning Inspectorate No. EN010116	Scale@A1 1:2,500	
Drawn/Designed By: EB	Checked By: RP	Approved By: RP
Drawing No. NLGEP-LDA-XX-XX-DR-L-0106	Revision P1	

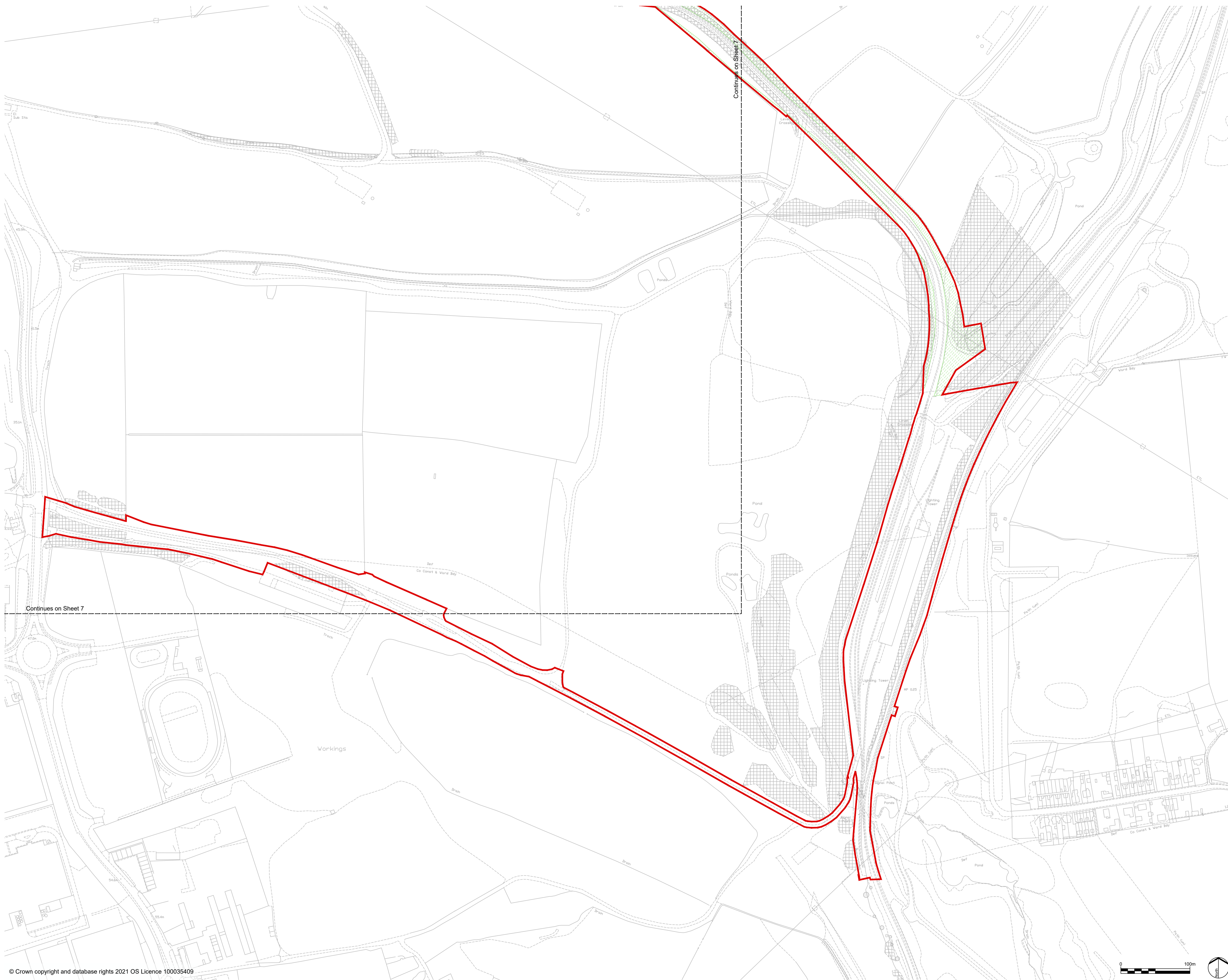



-  DCO Limits
- Understorey/Ground Cover**
-  Grassland
- Existing Landscape**
-  Existing Trees and Hedgerows

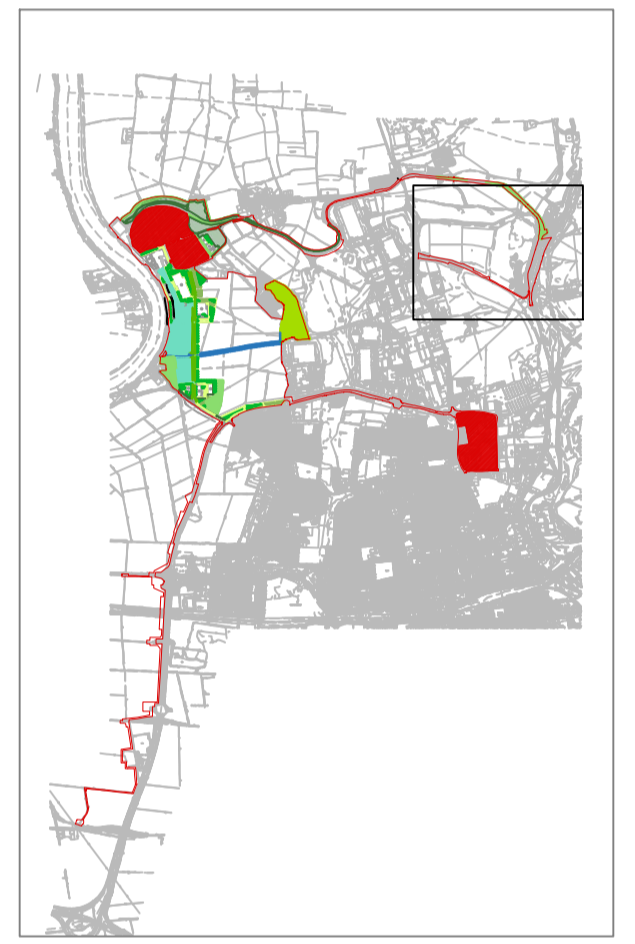

PO	Issued For DCO Submission	25/02/22	TE	EB	RP
Rev	Description	Date	Iss'd	Rev'd	App'd

DCO SUBMISSION

Project Stage

INFORMATION

Status of Drawing

Client



Level 33, Euston Tower, 296 Euston Road, London, NW1 3DF

LDADesign | GSDA | FIGHTNER
ERM





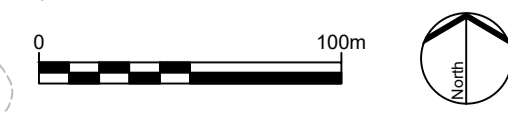

BURO HAPFOLD | northern planners | bowland ecology

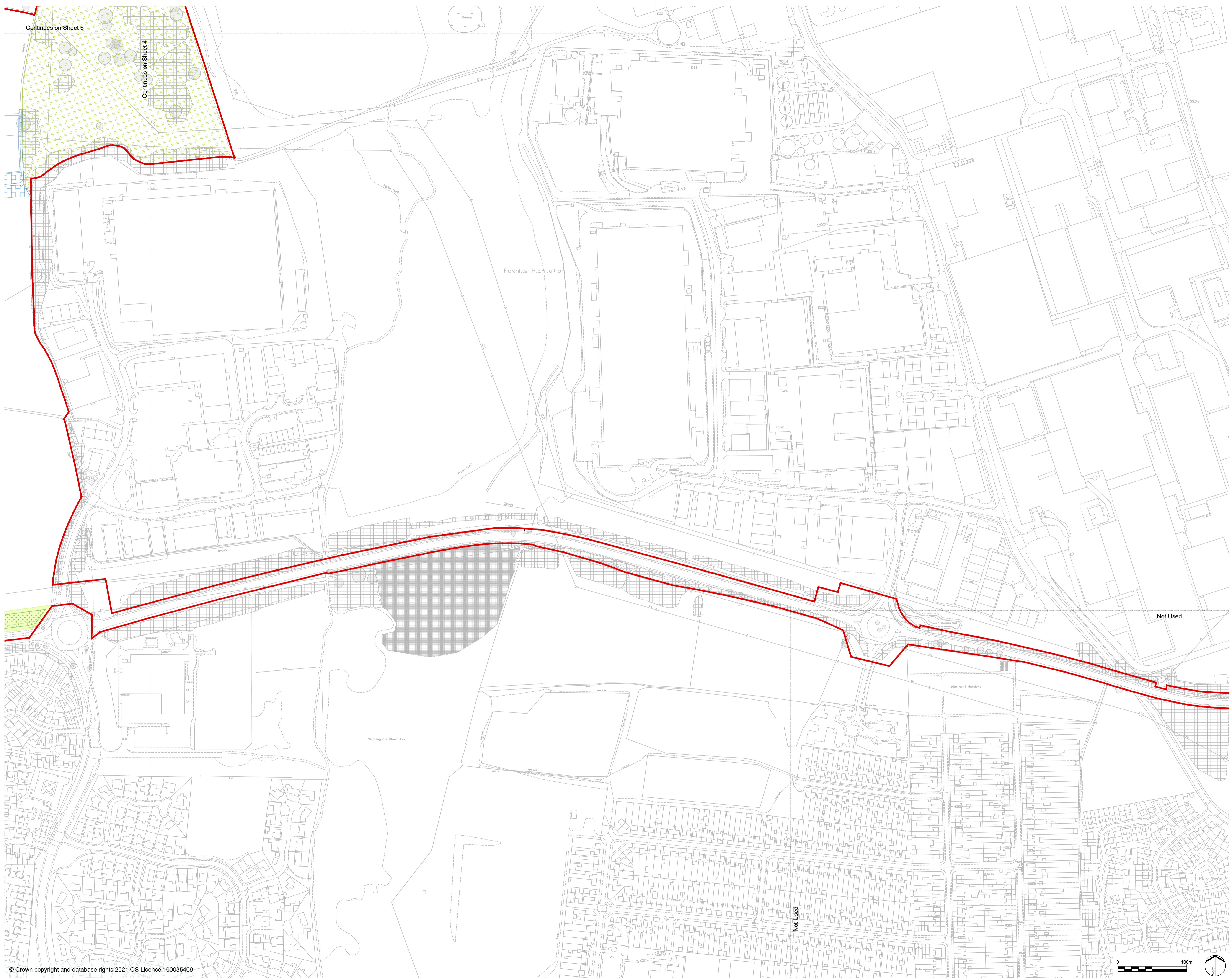
Client: NORTH LINCOLNSHIRE GREEN ENERGY PARK LTD
 Consultant: LDA Design Consulting Ltd
 Project: NORTH LINCOLNSHIRE GREEN ENERGY PARK
 Dwg Title: Indicative Landscape and Biodiversity Plan Sheet 8

Planning Inspectorate No. EN010116	Scale@A1 1:2,500	
Drawn/Designed By: EB	Checked By: RP	Approved By: RP
Drawing No. NLGEP-LDA-XX-XX-DR-L-0108	Revision PO	





-  DCO Limits
- Understorey/Ground Cover**
-  Wildflower & Wildflower Underplanting
- Tree Planting**
-  Low Scrub Planting Under Pylons
- Existing Landscape Enhancements**
-  Common land (identified for biodiversity enhancement)
-  Ditch Enhancement
- Existing Landscape**
-  Existing Trees and Hedgerows

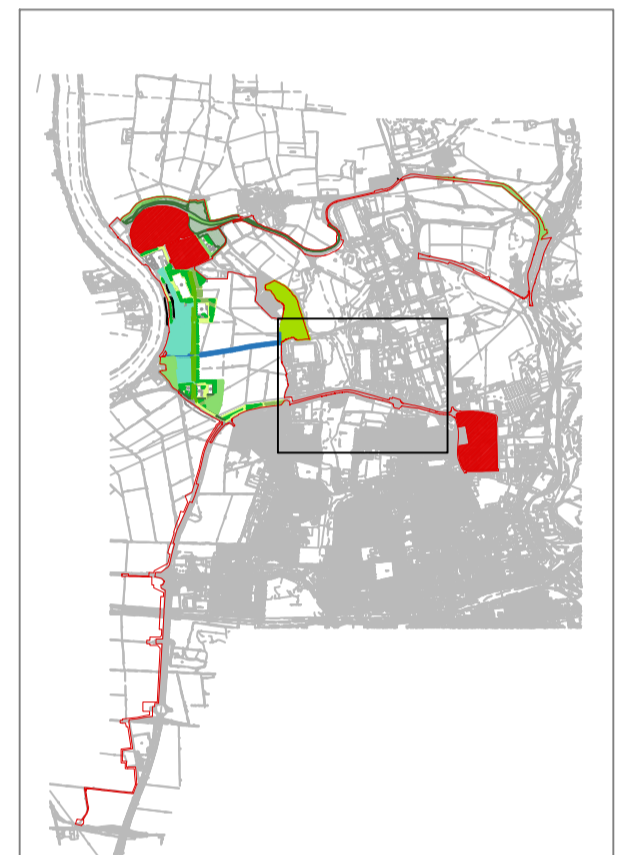

PO	Issued For DCO Submission	25/02/22	TE	EB	RP
Rev	Description	Date	Iss'd	Rev'd	App'd

DCO SUBMISSION

Project Stage

INFORMATION

Status of Drawing

Client

 Level 33, Euston Tower, 296 Euston Road,
 London, NW1 3DP

LDADesign | **GSDA** | **FICHTNER**
 ERM

BURO HAPFOLD | **northern planners** | **bowland ecology**

Client: NORTH LINCOLNSHIRE GREEN ENERGY PARK LTD
 Consultant: LDA Design Consulting Ltd
 Project: NORTH LINCOLNSHIRE GREEN ENERGY PARK
 Dwg Title: Indicative Landscape and Biodiversity Plan
 Sheet 9

Planning Inspectorate No. EN010116	Scale@A1 1:2,500	
Drawn/Designed By: EB	Checked By: RP	Approved By: RP
Drawing No. NLGEP-LDA-XX-XX-DR-L-0109	Revision PO	